



Totally-Tiffany™



# Build your own ScrapRack System

## ScrapRack System Design Guide

A note from Tiffany:

One of the coolest things about The ScrapRack is that it can be customized to work with your supplies. If you've got a lot of stuff, you can expand the system with expansion bases. If you love a particular size or shape of sticker or embellishment, you can choose the perfect size storage pages for just those items. Use the pages in this guide to help you choose what you'll use. All the links are clickable so you can learn more about each product, watch a video, or shop. As always, we've got the best customer service department on the planet, so call or email if you have questions. Thanks for considering The ScrapRack as your craft supply organization system.

**See page 7 for starter set recommendations.**

[Download a printable ScrapRack product pricelist now](#), or [click here for an online self-calculating pricelist](#).

253-284-9200 or [CustomerService@Totally-Tiffany.com](mailto:CustomerService@Totally-Tiffany.com)

*Tiffany*

[www.Totally-Tiffany.com](http://www.Totally-Tiffany.com)



## □ Step 1 - Where will you put your ScrapRack?

We have a little saying at the office, “*The ScrapRack makes room for itself.*” As you start eliminating boxes, bins, baskets, drawers, and totes – you’ll find plenty of space for your ScrapRack.

We recommend that you start with a space that is 12” deep, by 3’ long. This will give you ample room. The actual footprint of The ScrapRack is just 11.75” deep x 15” wide. It will sit easily on the top of a TV tray, as the “wings” don’t need a surface beneath them.

In a perfect world, it’s ideal to have your ScrapRack sitting next to you at chair height. You’ll be able to access everything quickly and easily while you work.



Tiffany has a triple base unit sitting on top of an IKEA Expedit 5-cube shelving unit. Since the time this was written, the Expedit has been replaced by the Kallax. The dimensions are basically the same, so the Kallax will work perfectly.

## □ Step 2 – Start with a ScrapRack Multicraft and 7 Spindlers



### The ScrapRack Multicraft Basic



The ScrapRack Basic is the foundation of your organization system.

Included in a Basic: the Velcro-covered base, 2 wings, and 7 three-ring Spindlers.

The full length of the ScrapRack Basic is 37” (including the extension of the wings).

### The ScrapRack Expansion Base

By linking Expansion Bases to the ScrapRack Basic, you can extend your ScrapRack out to the length you need. Each Expansion Base is 15” wide. Expansion bases can be added at any time.

The ScrapRack Expansion Base includes the Velcro-covered base, 8 Spindlers and 1 Velcro Connector. It cannot be used alone. [Click here to watch a video showing how ScrapRack bases link together.](#)

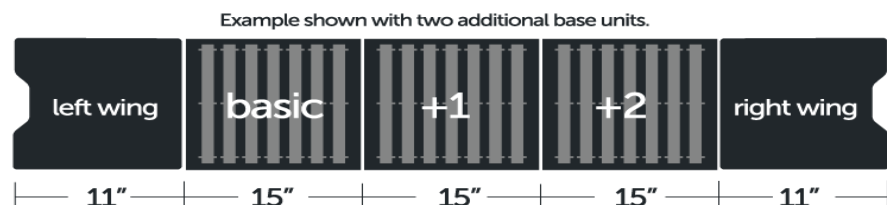

## □ Step 3 - Add Basic Storage Pages

### Basic Storage Pages

Plan on 20-30 pages per each 3-ring Spinder. This will vary depending on how bulky your supplies are, but this is a start. There are currently 12 designs available in our Basic Storage Page line. All of these designs share the same 12.5" x 12.5" footprint, with varying pocket configurations. These pages are made of an incredibly durable lightweight plastic.

A crescent cut flap on each pocket helps to secure supplies while providing easy access.

Individual designs are packaged with 10 pages per pack. A variety pack is also available, see page 5.

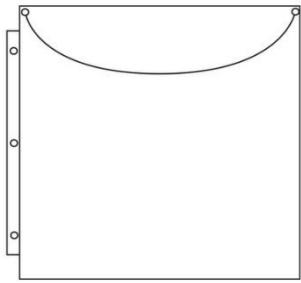

#### Super Sized Single

1 Pocket, 12x12"

SKU: P40

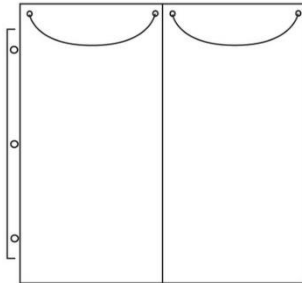

#### Vertical Double

2 Pockets, 6x12"

SKU: P80

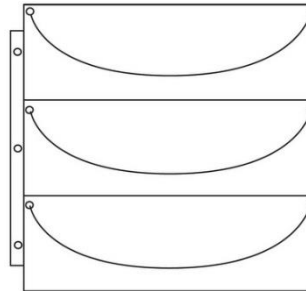

#### Triple Play

3 Pockets, 4x12"

SKU: P67

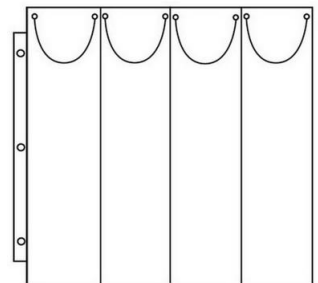

#### Vertical Four

4 Pockets, 3x12"

SKU: P59

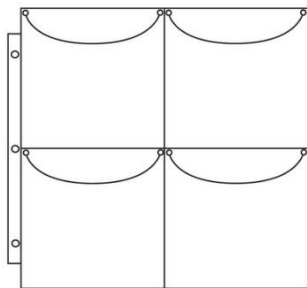

#### Fabulous Four

4 Pockets, 6x6"

SKU: P42

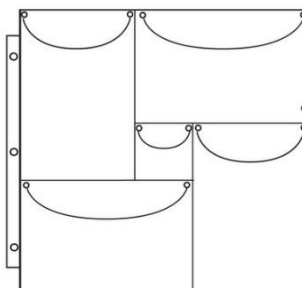

#### Fantastic Five

4 Pockets, 5x7"

1 Pocket, 1.5x1.5"

SKU: P72

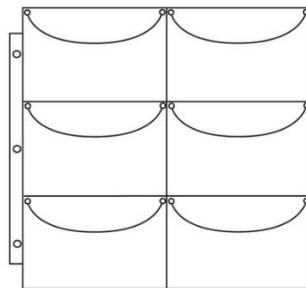

#### Perfect Six

6 Pockets, 4x6"

SKU: P43

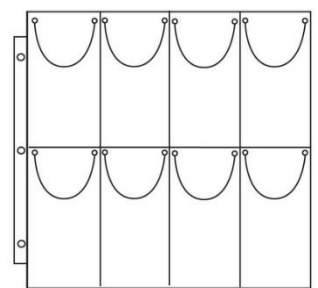

#### Straight Eight

8 Pockets, 3x6"

SKU: P66

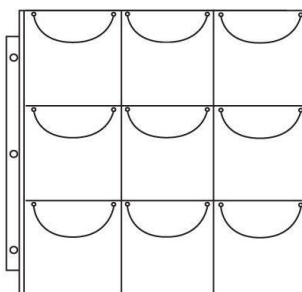

#### Simply Squared

9 Pockets, 4" x 4"

SKU: P9-84

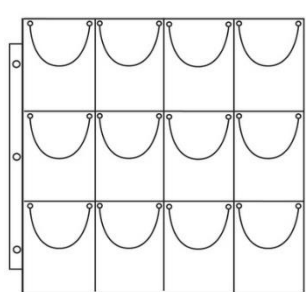

#### Trader's Twelve

12 Pockets, 3x4"

SKU: P44



## Double-Sided Duo Storage Pages

Two designs are currently offered in the Double-Sided Duo (DSD) page category.

Each design features a 12x12" pocket on the back side, with two options of pocket configurations on the front. These pages are made of the same material as our Basic Storage Pages. Individual designs are packaged with 10 pages per pack.

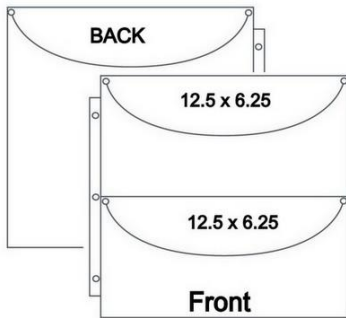

### Double Sided Duo 2x1

- 1 Pocket, 12x12" (back)
- 2 Pockets, 6x12" (front)

SKU: PD78

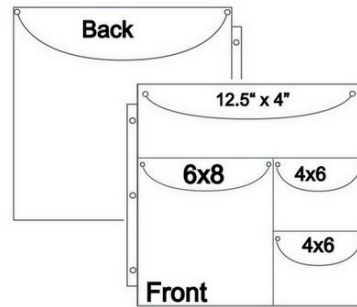

### Double Sided Duo 4x1

- 1 Pocket, 12x12" (back)
- 1 Pockets, 4x12" (front)
- 1 Pocket, 6x8" (front)
- 2 Pockets, 4x6" (front)

SKU: PD79

## Step 4 add Specialty Storage Pages



## Specialty Storage Pages

ScrapRack Specialty Storage pages are designed to accommodate more specific items than our Basic Storage pages. Each Specialty Page is made of a heavier gauge plastic and has unique features.

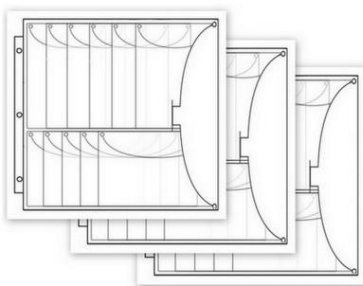

### Flippin' Storage

Flippin' Storage pages are layered with hinged pockets that "flip" to see the contents. There are six 4"x 6" Flippin' pockets on the top row and five 5 x 7" Flippin' pockets on the bottom row, plus a clear cover and locking flap.

These pages are great for embossing folders, unmounted stamps, photos, embellishments, card blanks, completed cards, and more!

3 Flippin' Storage pages per package.

SKU: P82

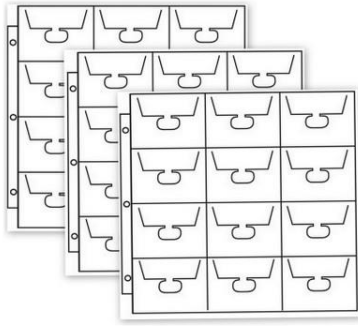

### Embellishment Pages

The Embellishment pages are double-sided with 12 gusseted pockets on each side, for a total of 72 pockets to hold the bulkiest supplies. Each pocket has a locking tab to keep contents secure. A large center pocket allows for storage of border stickers, die-cuts and other big stuff.

Each package includes 3 double-sided, tabbed pages and 72 zip bags.

SKU: P50

### Side Loader Single

The Side Loader Single pages are oversized 12" x 12" pockets, similar to our [Super Sized Single](#) pages. The difference is that these pockets are made of a heavier gauge plastic and will hold up to 25 sheets of paper. They load from the side and have a large flap, making them a favorite for taking supplies on the road. If your [ScrapRack](#) is on a higher shelf, these side-loading pages can make access to your supplies a little easier than a top-loading page.

5 Side Loader Single pages per package.

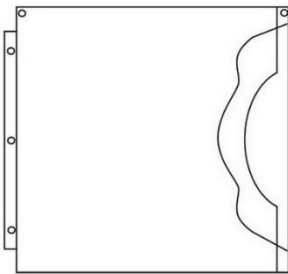

SKU: P51

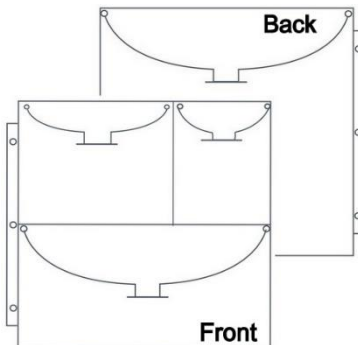

### Expanding Project Planner

The Expanding Project Planner pages work great for planning projects...and so much more! Keep kits and collections in these heavy-duty, gusseted, double-sided pages. Do you have some smaller "theme" categories in your [4-Section System](#)? This page can hold it all!

5 Expanding Project Planner pages per package.

SKU: P71



## Variety Page Packs

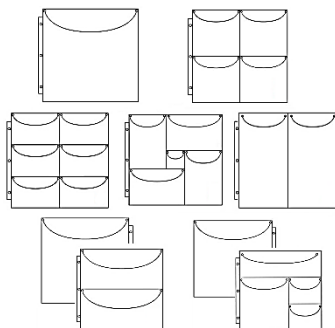

### **26 Page Variety Pack**

This package includes:

- 6 - [SuperSized Single Pages \(P40\)](#)
- 4 - [Fabulous Four Pages \(P42\)](#)
- 4 - [Perfect Six Pages \(P43\)](#)
- 4 - [Vertical Double Pages \(P80\)](#)
- 4 - [Fantastic Five Pages \(P72\)](#)
- 2 - [Double Sided Duo 2x1 Pages \(PD78\)](#)
- 2 - [Double-Sided Duo 4x1 Pages \(PD79\)](#)

SKU: PV26-3539

## □ Step 5 – Add Dividers

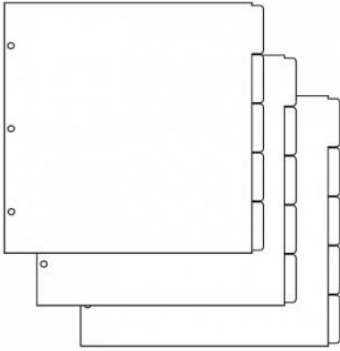

### ScrapRack Dividers

The Dividers serve 3 major purposes:

1. Labeling categories
2. Preventing page sag
3. Protecting the edges and corners of products

Dividers are available in a 5 pack ([A22](#)) and a 15 pack ([A31](#))  
We recommend 2-3 Dividers per Spinder.

## □ Step 6 – Add Accessories



### **ScrapRack Accessories**



#### Craft Binders

[Craft Binders](#) are a convenient way to sort, store, and travel with your supplies. They are the perfect accessory to a ScrapRack and will hold up to 3 Spinders. Each Craft Binder comes with a sample set of pages, 1 removable spinder (3 ring section), and a shoulder strap.

The interior of each [Craft Binder](#) is outfitted with loops and pockets for pens and tools. Colors vary

SKU: A24



#### Shut Your Flap

Our [Shut Your Flap sticky tabs](#) are great for crafters who really load up their ScrapRack Page pockets.

These cool little tabs are also a perfect way to label sections in a ScrapRack. Available in 2 sizes – [large](#) and [small](#)

SKU: Large: SYFLG031; Small: SYFSM048



#### Dust Cover

This lightweight fabric dust cover is designed to protect the items stored in a ScrapRack from light and Dust. Magnets in the hem hold the cover in place by sticking to the back panel of the ScrapRack.

SKU: A28

# ScrapRack Starter Kit Recommendations

## Beginner

Just getting started? This kit will be just right for you, or at least give you a solid start.

- B11 ScrapRack Basic with 7 Spinders
- A variety of pages based on your supplies – at least 50 (5 packages of Basic Pages)
- A31 Dividers – 15 pack

### **Additional Recommendations:**

- P40 SuperSized Single - 10 pk.
- P42 Fabulous Four - 10 pk.
- PB002 2x2 Zip lock type bag – 100ct.
- P80 Vertical Double - 10 pk.

## Serious Crafter

Do you have quite a lot of supplies? This is where you need to begin. A 2-base system is typical for seasoned crafters.

- B11 ScrapRack Basic with 7 Spinders
- B33 ScrapRack Expansion + 8 Spinders
- A variety of pages based on your supplies – at least 100 (10 packages of Basic Pages)
- A31 Dividers – 15 pack (x2)
- SYFLG031 Shut Your Flap Tabs – large

### **Additional Recommendations:**

- P50 Embellishment Storage Pages
- A31 Dividers – 15 pack
- PB002 2x2 Zip lock type bag – 100ct.
- P51 Sideloader Singles

## Crazy for Crafting Supply Collector

You know who you are. You've got a LOT of stuff. Don't worry – we've got you covered. Some ScrapRack users have 8 base units! Here we start with 3 - you can always add bases as you get organized.

- B11 ScrapRack Basic with 7 Spinders
- B33 ScrapRack Expansion + 8 Spinders (x2)
- A variety of pages based on your supplies – at least 150 (15 packages of Basic Pages)
- PV62 SuperSized Single 50 pg. pk.
- P50 Embellishment Pages
- P71 Expanding Project Planner Pages
- P82 Flippin' Storage Pages
- A31 Dividers – 15 pack (x4)
- SYFLG031 Shut Your Flap Tabs – large
- A28 ScrapRack Dust Cover (x2)

### **Additional Recommendations:**

- A31 Dividers – 15 pk
- PB002 2x2 Zip lock type bag – 100ct.
- P80 Vertical Double 10 pk